

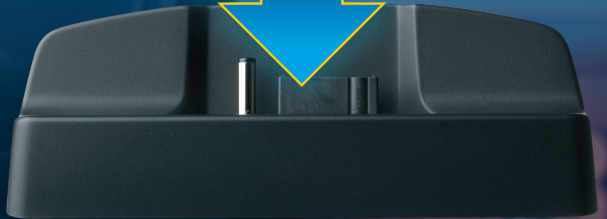

# XM Dock & Play

## HOME KIT

### User Guide



**SIRIUS**  |   
S A T E L L I T E   R A D I O



# Table of Contents

<b>Introduction</b> .....	<b>5</b>
Features .....	6
Safety and Care Information .....	7
What's in the Box? .....	8
Home Dock .....	9
<b>Home Installation</b> .....	<b>11</b>
Step 1: Connect the Home Dock .....	12
Step 2: Install the Indoor/Outdoor Antenna .....	16
<b>Troubleshooting</b> .....	<b>21</b>
<b>Product Specifications</b> .....	<b>25</b>
Patent Information .....	27
Environmental Information .....	27





# Introduction

## Features

### **Congratulations on your purchase of the XM Dock & Play Home Kit!**

Your new Home Kit lets you play your compatible XM Dock & Play radio through your home stereo system or powered speakers.

- **Bring Satellite Radio home:** No need for a second subscription. Just hook up this Kit to an existing home, office, or other stereo system or powered speakers.
- **Listen with any system:** Works with any stereo system or powered speakers that have audio input jacks.

And for the latest information about this and other SIRIUS | XM products and accessories, visit [xmradio.com](http://xmradio.com) or your favorite retailer.

**Please read the entire User Guide before installing your Home Kit!**

## Safety and Care Information



**IMPORTANT!** Always read and understand all the instructions to avoid injury to yourself and/or damage to your device. SIRIUS XM Radio Inc. disclaims all responsibility for damage from data loss due to breakdown, repair, or other causes.

- Do not expose to extreme temperatures (above 140°F or below -4°F, or above 60°C or below -20°C).
- Do not expose to moisture. Do not use device near or in water. Do not touch the device with wet hands.
- Do not let any foreign matter spill into device.
- Do not store in dusty areas.
- Do not expose to chemicals such as benzene and thinners. Do not use liquid or aerosol cleaners. Clean with a soft damp cloth only.
- Do not expose to direct sunlight for a prolonged period of time, and do not expose to fire, flame, or other heat sources.
- Do not try to disassemble and/or repair device yourself.
- Do not drop your device or subject it to severe impact.
- Do not place heavy objects on device.
- Do not subject device to excessive pressure.

### WARNING!

- Opening the case may result in electric shock.
- Make sure that you insert the Home Power Adapter's plug all the way into the outlet.

# Introduction

## What's in the Box?

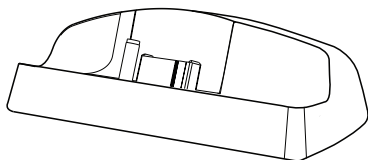

Home Dock

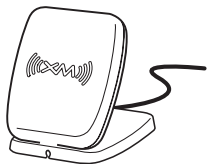

Indoor/Outdoor  
Antenna

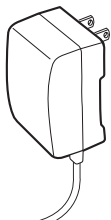

Home Power  
Adapter

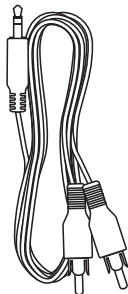

Stereo Audio  
Cable



**TIP!** If you prefer to use a Remote Control, and you want to add one to your Home Kit, visit [xmradio.com/accessories](http://xmradio.com/accessories) or your favorite retailer.



## Home Dock

### Connections

Rear View

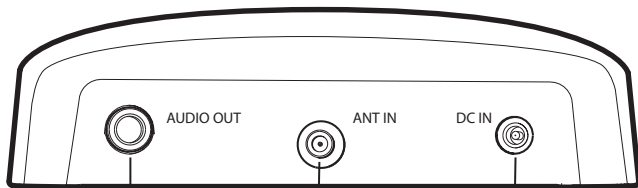

**AUDIO OUT**  
Connection for home  
stereo system or  
powered speakers.

**ANT IN**  
Connection for  
the Indoor/  
Outdoor  
Antenna.

**DC IN**  
Connection for  
Home Power  
Adapter.



# Home Installation

# Home Installation

There are two parts to setting up your Home Kit. First, connecting the Home Dock to your stereo or powered speakers, then placing and aiming the Home Antenna. Let's start with getting your Home Dock set up.

## Step 1: Connect the Home Dock

When installing the Home Dock in your home, choose a location in close proximity to your home stereo system or powered speakers, and also where the cable from the Indoor/Outdoor Antenna can reach the Home Dock. The location should be easily accessible and provide good visibility of the display, but should not be located where it will be in direct sunlight, which will affect the visibility of the display screen.

You will also need to decide whether you will be connecting your Home Dock to your home stereo system using the provided Stereo Audio Cable, or directly to powered speakers.

### Connect the Indoor/Outdoor Antenna

Once you have selected a location, connect the antenna to the **ANT IN** connector at the rear of the Home Dock. (After completing a few additional steps, we will work on the location of the antenna.)

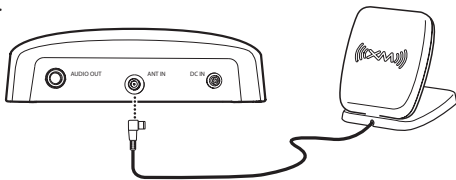

## Connect the Home Power Adapter

Connect the Home Power Adapter to the **DC IN** connector at the rear of the Home Dock, and plug it into a wall outlet.

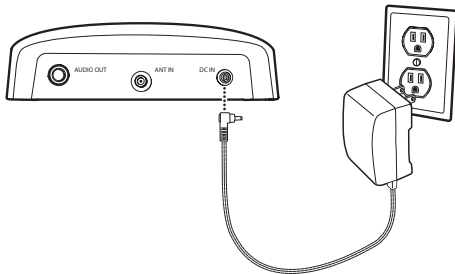

## Connect the Home Dock to a Home Stereo System or Powered Speakers

The Home Dock can be connected to your home stereo system, or to a pair of powered speakers. If you are connecting to a home stereo system, see the following section. If you are connecting to a pair of powered speakers, see “To Connect the Home Dock to Your Powered Speakers” on page 15.

### *To Connect the Home Dock to Your Home Stereo System*

The Home Dock can be connected to your home stereo system through the

# Home Installation

AUX IN or LINE IN connection of your home stereo system, using the provided Stereo Audio Cable.

- 1 Take the provided Stereo Audio Cable and connect the single 1/8" (3.5 mm) connector to the **AUDIO OUT** connector at the rear of the Home Dock.
- 2 Connect the white left and red right Stereo Audio Cable connectors ("L" and "R" are also on each respective tip) to any available input other than PHONO on your home stereo system. (If your stereo's inputs are marked red and black, simply connect the white plug to the black input.)

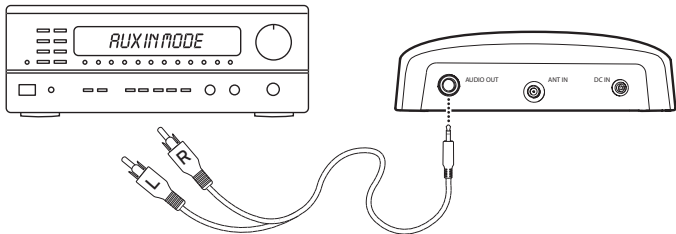

- 3 Turn the home stereo system On, and make sure you select the correct input on your stereo system for the **AUX In** or **LINE In** connection.

### *To Connect the Home Dock to Your Powered Speakers*

The Home Dock can be connected directly to a pair of powered speakers.

- 1 Connect the 1/8" (3.5 mm) connector from the powered speakers to the **AUDIO OUT** connector at the rear of the Home Dock.

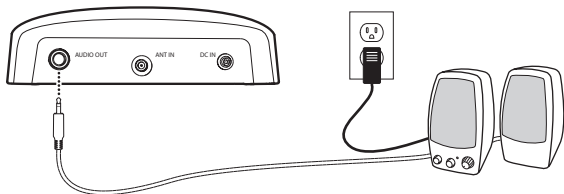

- 2 Plug the powered speakers into an AC outlet.
- 3 Turn On the powered speakers.

### **Dock Your Radio**

Place your radio into the Home Dock as shown, and turn the radio On by pressing the **Power** button.

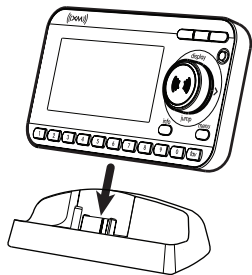

# Home Installation

## Step 2: Install the Indoor/Outdoor Antenna

To begin, try experimenting with the Home Antenna to get a feel for the reception in your location. Move the antenna around the room or from room to room. Aim it from different windows. In major metropolitan areas, you might find that you get great reception in several locations without worrying too much about aim and placement.

Refer to your radio's User Guide for instructions, and access the **Signal** or **Signal Indicator** screen of your radio to see a visual indication of signal strength. If you're receiving a good Satellite and Terrestrial signal strength, you're done. If not, try some of the suggestions which follow.

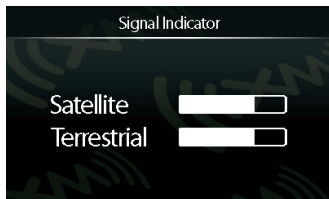

### *Other Indoor/Outdoor Antenna Installation Suggestions*

If you find you are getting a signal, but it's inconsistent, try moving the Indoor/Outdoor Antenna closer to a window, ideally one that is facing due south.

Not sure which way is south? Think about where the sun rises (in the east) and sets (in the west). Then stand so that east is to your left and

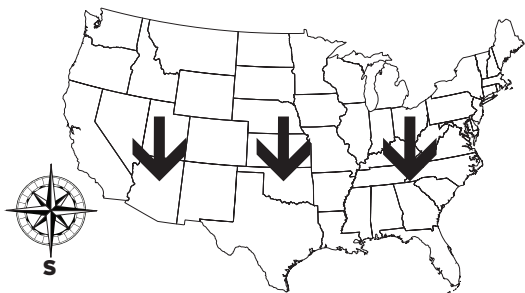



you'll be facing south. Is there a window in the direction you're facing? Move the antenna closer to the window.



**TIP!** Still not sure which way is south or where to place your Home Antenna? Look up your location on an online mapping Web site that offers satellite views of street addresses where you can easily see which way is south, and what window may offer an unobstructed view of the sky.

Another easy method is to start at any window, then work from window to window in a simple pattern to find the window gives the best signal strength. Note that the antenna must also have an unobstructed view. No trees or buildings blocking its aim. If the antenna is aimed through a window, be aware that blinds, screens, or any other non-glass elements such as thermal insulation can sometimes cause reception issues. If this is the case, you may want to use another window or place the antenna outside of the window.

If you find a window that gives you good signal strength, you can place the antenna on the windowsill. The antenna may need to be placed on something to raise it above the level of the window frame.

If you don't have a window where you receive a consistent signal, or placing the antenna in a window is not a practical solution for you, **BETTER** reception can be achieved by placing the antenna outside on a window ledge, porch, table, or patio. The location you choose should provide the antenna with a clear view of

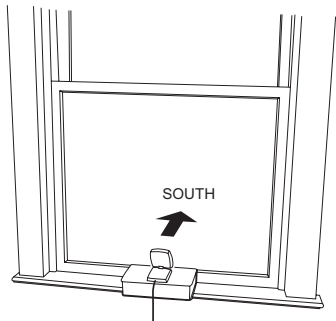

# Home Installation

the southern sky.

If none of the previous solutions work for you, then the **BEST** reception can be achieved by mounting the antenna outdoors, with a clear view of the southern sky.

Note that you will want to consider any potential hazards when you choose the mounting location, and possibly consider professional installation. SIRIUS XM Radio Inc. is not liable for any damages.

To mount the antenna, you will need four screws (not included) with a 1/4" head (e.g., an M3 screw), and that are suitable for the material onto which you are affixing the antenna, (e.g., wood, metal, etc.). The screws should be spaced 1-3/8" apart horizontally and 1-1/8" vertically. Refer to the template on "Indoor/Outdoor Antenna Template" on page 30.

Once you have found a suitable location for the antenna, route the antenna cable

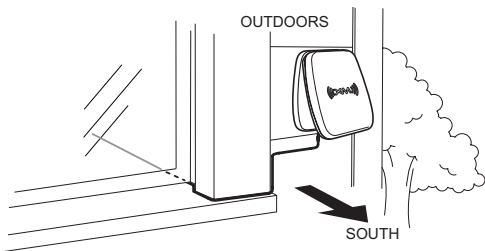
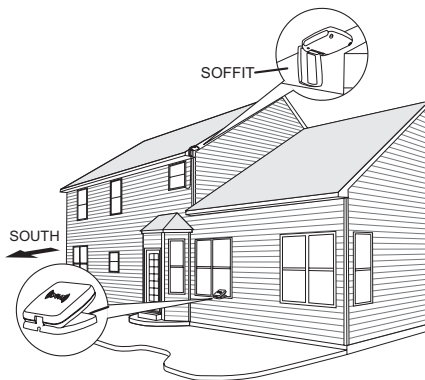

to the Home Dock. Be sure you avoid any obstructions that could crimp, kink, or twist the cable. Use protective grommets wherever rough openings are encountered. If the antenna is installed outdoors, route the cable from the antenna location to the interior of the home, working the cable through the basement, under a window sill, etc., and make adjustments to take up cable slack as necessary.



**TIP!** If your Indoor/Outdoor Antenna's cable isn't long enough, visit [xmradio.com/accessories](http://xmradio.com/accessories), or your favorite retailer, and consider a 50 ft. Indoor/Outdoor Antenna Extension Cable or a Wireless Home Signal Repeater.

If the signal is good for either Satellite or Terrestrial (or both), and you are hearing the audio from the radio, the installation is complete.

If the signal reception is low, or intermittent, try another location for the antenna. Verify that the antenna is pointed south, and that the antenna's view of the sky is not blocked by a tree, a building, a bridge, or anything else. Adjust until you are receiving a good signal.

The Indoor/Outdoor Antenna's reception can also be tweaked by opening or closing the antenna clamshell, and turning the antenna. While observing the signal strength, make small adjustments to the angle of tilt of the clamshell until the highest possible signal strength is achieved. If you have not wall-mounted the antenna, turn the antenna slightly to the right or left and

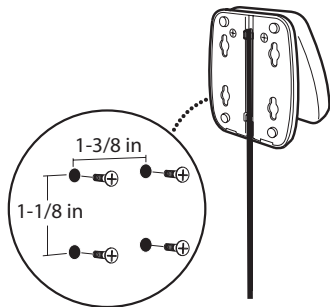

# Home Installation

observe if the signal strength increases. For each tweak, allow a few seconds in each position to determine if the signal strength increases.

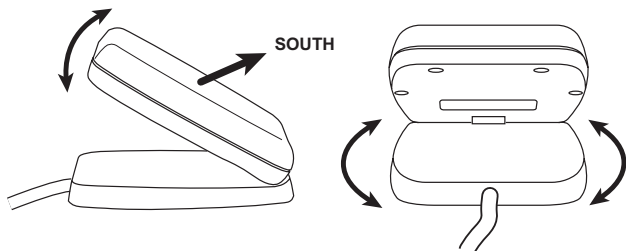

If the signal reception is good, but there is no audio, verify your audio connection.

- If you are connected to a home stereo system, be sure the system is set to the auxiliary input source, and you have connected the Stereo Audio Cable to the auxiliary input connectors.
- If you are connected to powered speakers, be sure the speakers are plugged into an outlet, and are turned On.

The audio level of your radio can also be increased. Refer to the User Guide which accompanied your radio and increase the audio level.

If you still have questions, for example, 'Are there any other options/things I should consider?', etc., refer to "Troubleshooting" on page 22.

# Troubleshooting

# Troubleshooting

Your Home Kit has been designed and built to be trouble-free, but if you experience a problem, try this:

- Check that all connections are firm and secure.
- Make sure you have connected the Home Dock as described in this User Guide. Verify that the AC power outlet is working.

<b>If you see this on the screen:</b>	<b>Try this:</b>
Acquiring Signal	<ul style="list-style-type: none"><li>• Move the antenna to a south-facing window. Not sure which way is south? Think about where the sun rises (in the east) and sets (in the west). Then stand so that east is to your left and you'll be facing south. Is there a window in the direction you're facing?</li><li>• You may need to find a better location for the antenna. Refer to "Step 2: Install the Indoor/Outdoor Antenna" on page 16.</li></ul>
Check Antenna	<ul style="list-style-type: none"><li>• Make sure that the Indoor/Outdoor Antenna cable is firmly and securely plugged into the Home Dock. Make sure the cable is not bent or broken.</li><li>• Turn the radio off, then on, to reset this message.</li></ul>
Channel Off Air	<ul style="list-style-type: none"><li>• The channel you've selected is not currently broadcasting. Tune to another channel.</li></ul>
Loading	<ul style="list-style-type: none"><li>• Your radio is acquiring audio or program information. This message usually goes away in a few seconds.</li></ul>

<b>If you see this on the screen:</b>	<b>Try this:</b>
Updating	<ul style="list-style-type: none"> <li>• Your radio is being updated with the latest encryption code. Wait until the update is done.</li> <li>• You may be trying to tune to a channel that is blocked or unavailable. Tune to another channel.</li> </ul>
–	<ul style="list-style-type: none"> <li>• No program information, such as artist name, song title, or channel exists.</li> </ul>
<b>If this happens:</b>	
You do not receive all the channels to which you subscribed	<ul style="list-style-type: none"> <li>• If you have not yet activated your service, refer to the Activation section in the User Guide which accompanied your radio.</li> </ul>
No audio	<ul style="list-style-type: none"> <li>• Check all cables between your radio and your home stereo system or powered speakers for a firm and secure connection.</li> <li>• Ensure you have selected the proper input source on your home stereo system.</li> <li>• Increase the audio level of the radio. Refer to the User Guide which accompanied your radio for instructions.</li> </ul>
Audio sounds too soft	<ul style="list-style-type: none"> <li>• Raise the volume of your home stereo system or powered speakers, or increase the audio level of your radio until the sound quality improves. Refer to the User Guide which accompanied your radio for instructions.</li> </ul>

# Troubleshooting

If this happens:	Try this:
Audio fades or has static when listening	<ul style="list-style-type: none"><li>• Check all cables for a firm and secure connection.</li></ul>
No song title or artist name is displayed	<ul style="list-style-type: none"><li>• The information may not be available or updates may be in progress.</li></ul>
Traffic and Weather channels sound different from other channels	<ul style="list-style-type: none"><li>• These channels use a different audio technology than other channels so they often sound different from other channels.</li></ul>
The radio shuts off unexpectedly	<ul style="list-style-type: none"><li>• If your radio has these features, check these:</li><li>• If Sleep Timer is set, the radio will turn off after the selected length of time in a Home Dock/ sound system. Set Sleep Timer to Off.</li><li>• If Delayed Power is set, the radio will turn off after the selected length of time in the Home Dock. Set Delayed Power to Off.</li></ul>
The demo is playing	<ul style="list-style-type: none"><li>• Your Indoor/Outdoor Antenna is not connected or you are not receiving the signal. Check that the Indoor/Outdoor Antenna is connected properly and is not obstructed.</li></ul>



# Product Specifications

# Product Specifications

## Dimensions

Home Dock  
93 mm (W) X 29 mm (H) X 38 mm (D)  
3.6 in (W) X 1.1 in (H) X 1.5 in (D)

## Audio Output

3.5 mm (1/8 in) diameter mini stereo jack

## Weight

Home Dock  
109 g (3.8 oz)

## Lineout Level

1.5Vrms max into auxiliary input  
20mW max into 16 ohm headphones

## External Power

Voltage  
5.2V DC  
Current  
1.6A

## Cable Lengths

Indoor/Outdoor Antenna  
6 m (20 ft)  
Stereo Audio Cable  
91 cm (3 ft)

# Patent and Environmental Information

## Patent Information

It is prohibited to, and you agree that you will not, copy, decompile, disassemble, reverse engineer, hack, manipulate, or otherwise access and/or make available any technology incorporated in this product. The music, talk, news, entertainment, data, and other content on the Services are protected by copyright and other intellectual property laws and all ownership rights remain with the respective content and data service providers. You are prohibited from any export of the content and/or data (or derivative thereof) except in compliance with applicable export laws, rules and regulations. The user of this or any other software contained in a SIRIUS | XM radio is explicitly prohibited from attempting to copy, decompile, reverse engineer, hack, manipulate or disassemble the object code, or in any other way convert the object code into human-readable form.

## Environmental Information

Follow local guidelines for waste disposal when discarding packaging and electronic appliances.

Your Home Kit is packaged with cardboard, polyethylene, etc., and does not contain any unnecessary materials.

# FCC Statement

The user is cautioned that changes or modifications not expressly approved by SIRIUS XM Radio Inc. can void the user's authority to operate this device.

This device complies with Part 15 of the FCC Rules. Operation is subject to the following two conditions:

1. This device may not cause harmful interference.
2. This device must accept any interference received, including interference that may cause undesired operation.

This equipment has been tested and found to comply with the limits for a Class B digital device, pursuant to Part 15 of the FCC Rules. These limits are designed to provide reasonable protection against harmful interference in a residential installation.

This equipment generates, uses, and can radiate radio frequency energy and, if not installed and used in accordance with the installation instructions, may cause harmful interference to radio communications. However, there is no guarantee that interference will not occur in a particular installation. If this equipment does cause harmful interference to radio or television reception, which can be determined by turning the equipment off and on, the user is encouraged to try to correct the interference by one or more of the following measures:

- Reorient or relocate the receiving antenna of the affected receiver.
- Increase the separation between the SIRIUS | XM equipment and the affected receiver.
- Connect the SIRIUS | XM equipment into an outlet on a circuit different from that to which the affected receiver is connected.
- Consult the dealer or an experienced radio/TV technician for help.

**WARNING!** The FCC and FAA have not certified Satellite Radio Receiver use in any aircraft (neither portable nor permanent installation). Therefore, SIRIUS XM Radio Inc. cannot support this type of application or installation.

# Copyrights and Trademarks

Hardware and subscription sold separately. Activation fee, other fees, and taxes required. Installation required with some equipment. Except for the MiRGE radio, and as specifically provided, SIRIUS and XM Radios and accessories are compatible only with their respective subscription service. Subscriptions governed by, as applicable, the SIRIUS Terms & Conditions available at [sirius.com](http://sirius.com), or the XM Customer Agreement available at [xmradio.com](http://xmradio.com). Prices and programming are subject to change. SIRIUS XM U.S. Service only available in the 48 contiguous United States and D.C. Service available in Canada; see [www.siriuscanada.ca](http://www.siriuscanada.ca) or [www.xmradio.ca](http://www.xmradio.ca). © 2009 SIRIUS XM Radio Inc. SIRIUS, XM and all related marks and logos are trademarks of SIRIUS XM Radio Inc. and its subsidiaries. All other trademarks, service marks and logos are the property of their respective owners. All rights reserved.

**WARNING:** This product contains chemicals known to the State of California to cause cancer and birth defects or other reproductive harm.

# Indoor/Outdoor Antenna Template

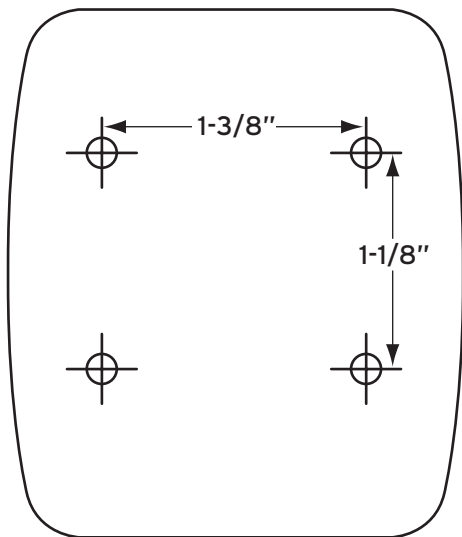



xmradio.com

SIRIUS XM Radio Inc.  
1221 Avenue of the Americas  
New York, NY 10020

1.800.967.2346

© 2009 SIRIUS XM Radio Inc.

XM Dock & Play Home Kit User Guide (XDPHKUG0809) 092509a