

# 1 Insert the Radio Dock Adapter Into the Dock

You'll need to insert the Radio Dock Adapter that is compatible with your Radio into the Vehicle Dock.

- A. Locate the Radio Dock Adapter that is compatible with your Radio.

**If you have an XM or SiriusXM Radio:** If your Radio is branded as **XM\*** or **SiriusXM\***, select the Radio Dock Adapter marked **XM & SIRIUSXM** on the back of the adapter.

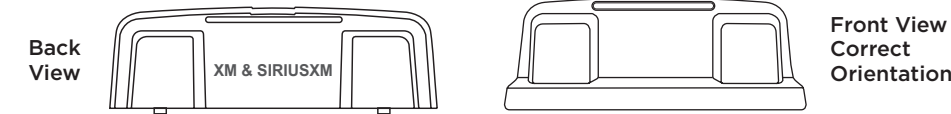

**If you have a Sirius Radio:** If your Radio is branded as **Sirius\***, select the Radio Dock Adapter that is marked **SIRIUS** on the back of the adapter.

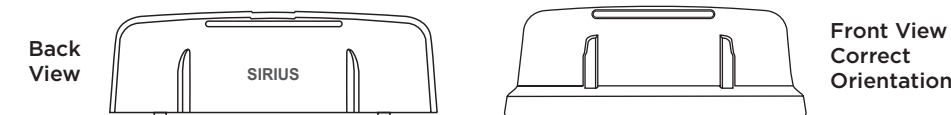

- B. Orient and place the Radio Dock Adapter that you selected into the Vehicle Dock. Be sure the adapter is centered, and is seated all the way down into the dock.

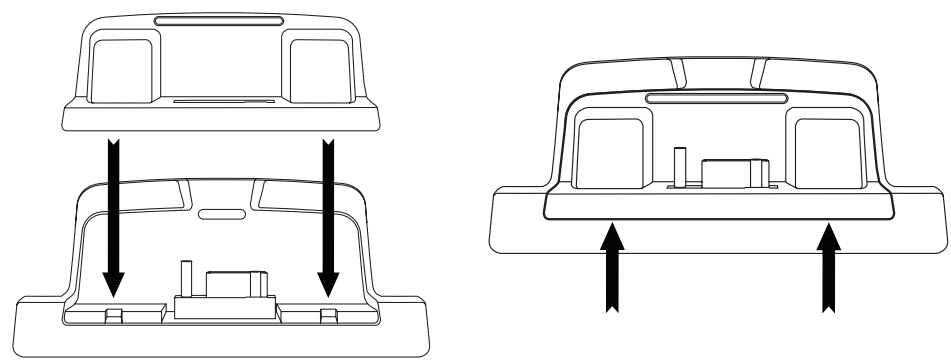

- C. Once the adapter is seated correctly in the Vehicle Dock, gently press the top of the adapter against the dock with your finger until it clicks into place. The Radio Dock Adapter is now installed.

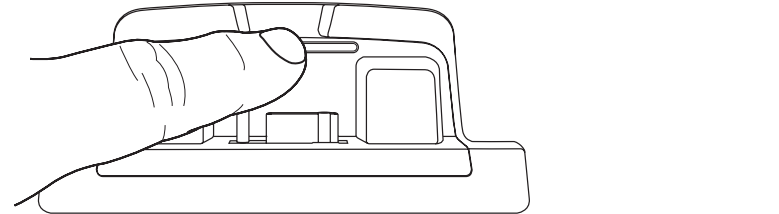

Should it become necessary to remove the Radio Dock Adapter from the Vehicle Dock, use your fingernail to gently press down on the top of the adapter, and then use a long thin object such as a paper clip, a screw driver, or something similar to pry the adapter away until it releases from the dock. Then lift the adapter up and out of the dock.

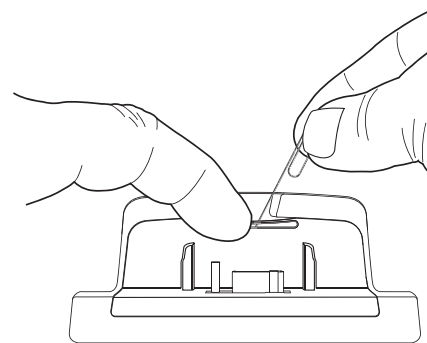

\*If you are unsure whether your Radio is an XM, SiriusXM, or Sirius Radio, check the label on the back of the Radio. If the label on your Radio says XM Radio ID or Radio ID, and has an 8-digit alphanumeric number, it is an XM or SiriusXM Radio. If the label on your Radio says Sirius ID, SID, or ESN, and has a 12-digit numeric number, it is a Sirius Radio.

# 2 Find a Location for the Vehicle Dock and Mount it

Select either the **Dash Mount** or the **Vent Mount** method for mounting the Vehicle Dock. You will need a phillips screwdriver to complete the installation.

**NOTE:** Your Radio may be a different model than the Radio shown here.  
**TIP!** You can take advantage of the wire guide channel across the back of the Vehicle Dock to organize the wires which connect to the dock.

## Dash Mount Method:

**IMPORTANT:** The air temperature needs to be at least 60°F to install the Dash Mount. If needed, turn on the heater in your vehicle.

- A. Select a flat surface for the Dash Mount with ample room for the Vehicle Dock and Radio. Avoid mounting on leather surfaces. Choose a location that doesn't interfere with the driver's vision or access to driving controls, one that won't interfere with the deployment of airbags or other safety equipment, and makes your Radio easily accessible for operation. (Airbag locations are typically marked with "SRS" logos.)

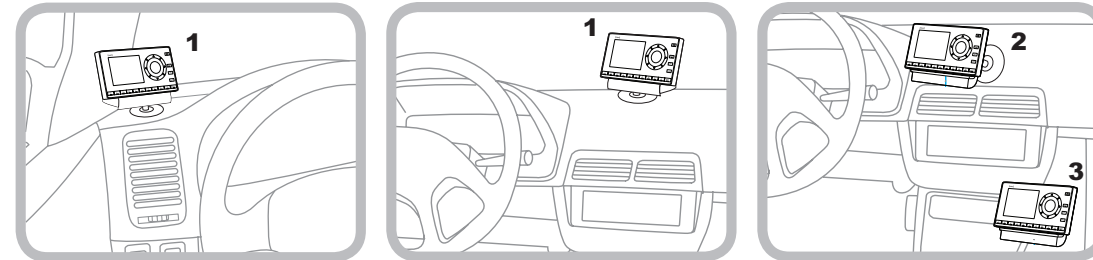

- B. Orient the adhesive foot so that your Radio is easily accessible. Loosen the knob and adjust the adhesive foot to position **1, 2, or 3**, and then tighten it.

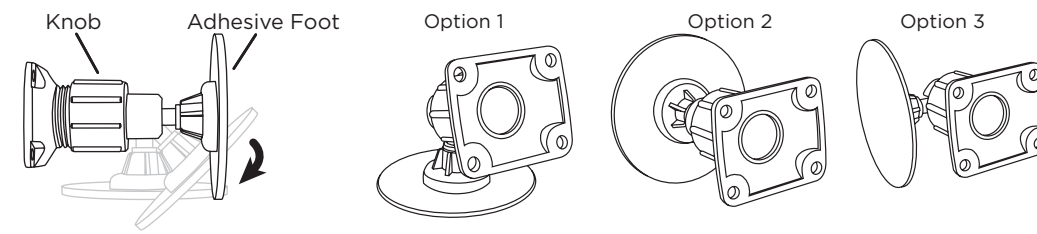

- C. Attach the Dash Mount to the *PowerConnect* Vehicle Dock using the 4 provided screws. If you plan to use the wire guide channel across the back of the Vehicle Dock to organize the wires, do not fully tighten the screws. If not, tighten the screws.

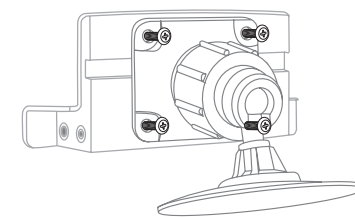

- D. Clean the mounting surface in the vehicle with the alcohol preparation pad and let it dry thoroughly.  
E. Once the surface is dry, remove the adhesive liner. Press and hold the Dash Mount in place for 30 seconds. Allow the adhesive to cure for at least 2-4 hours.  
F. You can tilt the dock mounting plate in your preferred direction. (Note that for clarity the illustration does not show the Vehicle Dock attached to the Dash Mount.)

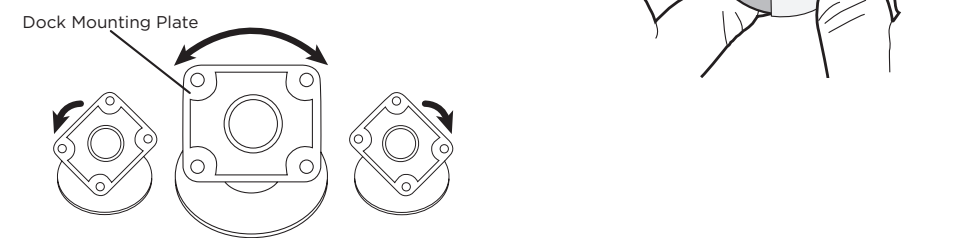

## Vent Mount Method:

- A. Select a vent with ample room for the Vehicle Dock and Radio, one that won't interfere with the deployment of airbags or other safety equipment, and makes your Radio easily accessible for operation. (Airbag locations are typically marked with "SRS" logos.)

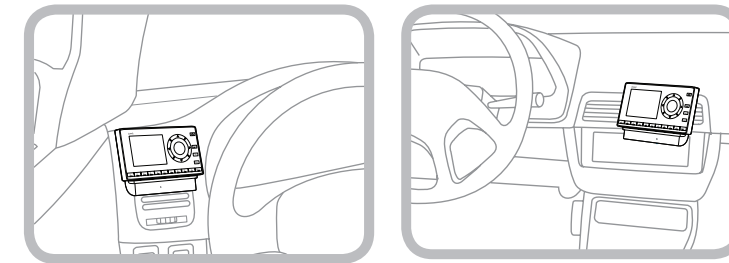

- B. Some vents have recessed louvers. If yours are recessed, remove the regular vent clamps and install the extended vent clamps.

### Vent Mount Rear View

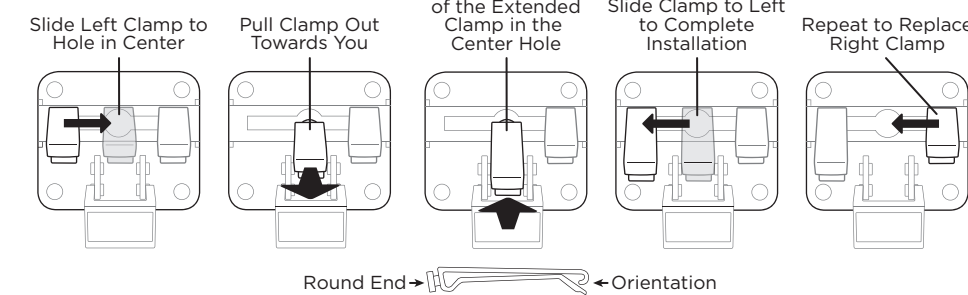

- C. Attach the Vent Mount to the *PowerConnect* Vehicle Dock using the 4 provided screws. If you plan to use the wire guide channel across the back of the Vehicle Dock to organize the wires, do not fully tighten the screws. If not, tighten the screws.

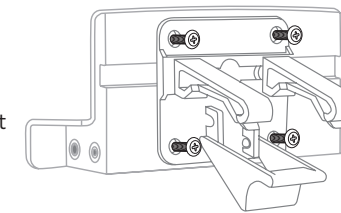

- D. Install the Vent Mount onto the vehicle vent. (Note that for clarity the illustrations below do not show the Vehicle Dock attached to the Vent Mount.)  
i. Insert the vent mount into the vent opening.  
ii. Push until hooked on the rear of the vent louver. Rest the foot against the bottom of the vent.  
iii. If necessary, adjust the tilt of the Vent Mount by repositioning the foot to a different tilt adjustment hole.

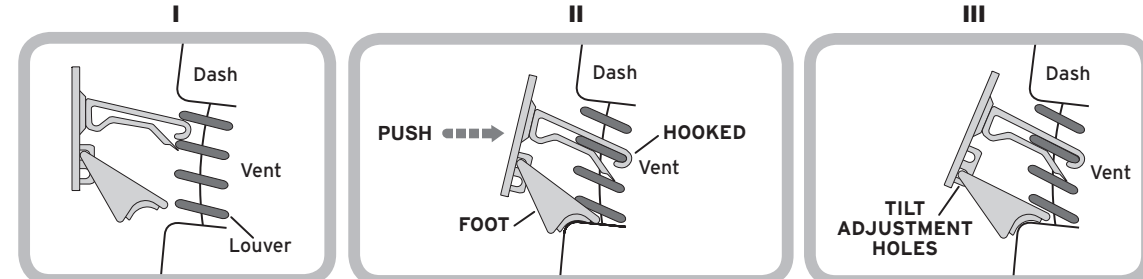

# 3 Mount the Magnetic Mount Antenna

- A. Mount the Magnetic Mount Antenna outside your vehicle, on a clean and dry horizontal surface that will always face the sky.  
B. Choose the location for the antenna according to your type of vehicle. Center it between the left and right sides, and away from other antennas.

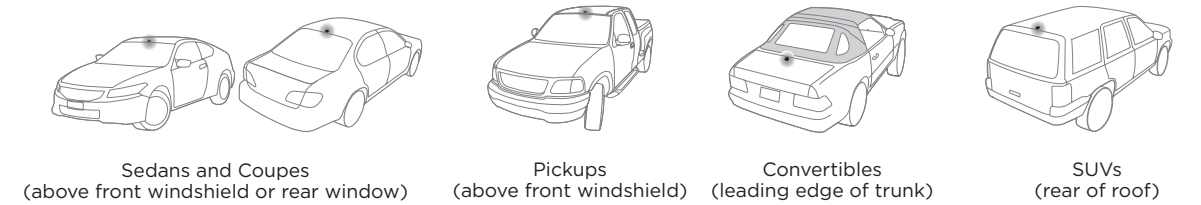

**TIP:** Use the Alcohol Prep Pad to clean the surface.

# 4 Route the Antenna Cable

**NOTE:** These instructions are for a sedan or coupe where the antenna is mounted above the front windshield. The SiriusXM Dock and Play Vehicle Kit User Guide SXDV3 has detailed antenna cable routing instructions for all types of vehicles. Go to [www.siriusxm.com/guides](http://www.siriusxm.com/guides) for the User Guide.

- A. Tuck the antenna cable under the windshield rubber molding and run it to the nearest corner.  
B. Route the cable out of the molding and into the rubber weather stripping around the door opening.  
C. Lift the weather stripping. Tuck and run the cable inside it to the bottom of the door opening. Replace the weather stripping.  
D. Pull the cable out and route it to your Radio.  
E. Plug the Magnetic Mount Antenna connector into the **silver ANT** connector on the side the Vehicle Dock.

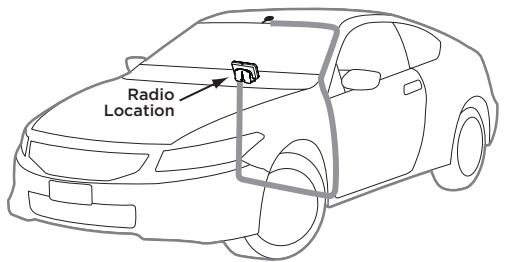

**TIP:** Include enough slack in your routing to accommodate open doors or the hood lid. Coil any excess cable in a hidden location and keep it away from any vehicle pedals or controls.

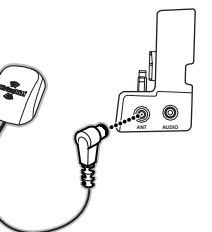



Dock & Play Vehicle Kit

## QUICK START GUIDE



Self installation instructions and tips are provided for your convenience. It is your responsibility to determine if you have the knowledge, skills and physical ability required to properly perform an installation. SiriusXM shall have no liability for damage or injury resulting from the installation or use of any SiriusXM or third party products. It is your responsibility to ensure that all products are installed in adherence with local laws and regulations and in such a manner as to allow a vehicle to be operated safely and without distraction. SiriusXM product warranties do not cover the installation, removal or reinstallation of any product.

Sirius XM Radio Inc.  
1221 Avenue of the Americas  
New York, NY 10020

[siriusxm.com](http://siriusxm.com)

1.866.635.2349

© 2014 Sirius XM Radio Inc.

SXDV3QSG 140731c

## 5 Connect the **PowerConnect Power Adapter**

- A. Insert the **PowerConnect Power Adapter** into your vehicle's 12 volt power adapter or cigarette lighter socket. Plug the other end into the **red PWR** connector on the side of the **PowerConnect Vehicle Dock**.
- B. Place your Radio into the dock and press the **Power button**.

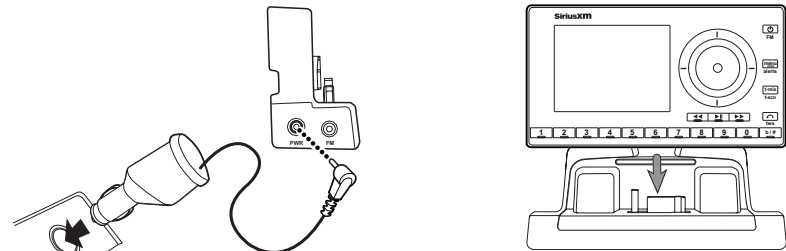

## 6 Verify Signal Reception

- A. Verify the signal reception by looking at the antenna signal strength bars on the screen. If the Radio is showing at least two vertical bars of antenna signal strength, continue with step 7. If not, be sure that you have mounted the antenna on the outside of the vehicle, as shown in step 3, and that the vehicle is parked outdoors with a clear view of the sky. Move the vehicle away from any obstructed area, for example, if you are parked in a garage, or parked near a large structure.
- B. Refer to your Radio's User Guide (go to [www.siriusxm.com/guides](http://www.siriusxm.com/guides)) for instructions on accessing the **Signal Indicator**, **Signal**, or **Antenna Aiming** screen of your Radio, to see a visual indication of signal strength.

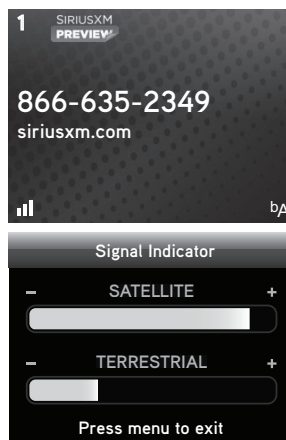

\*The screens shown above are representative and may differ from the screens displayed on your Radio.

## Specifications

<b>System</b>	Power Requirements: 9-16 V DC, 500 mA (max) Operating Temperature: -4°F to +140°F (-20°C to +60°C) Audio Output: 1.0 V <sub>rms</sub> (max)	Cable Length:	Approximately 4.6 ft. (1.4 m)
<b>PowerConnect Dock</b>	Dimensions: 4.1 in (W) x 1.8 in (H) x 1.1 in (D) 105 mm (W) x 46 mm (H) x 28 mm (D)	<b>Vehicle Antenna</b>	Type: SiriusXM Magnetic Mount Connector: SMB female, right angle Cable Length: Approximately 23 ft (7.0 m)
Weight (without adapter): 1.4 oz (40 g) Weight (with adapter): 1.5 oz (43 g)	Audio Connector: 1/8 in (3.5 mm) female Antenna Connector: SMB male	<b>Aux In Cable</b>	Connectors: 1/8 in (3.5 mm) stereo male to 1/8 in (3.5 mm) stereo male Cable Length: Approximately 4 ft (1.2 m)
<b>PowerConnect Power Adapter</b>	Dimensions: 3.7 in (W) x 1.7 in (H) x 1.3 in (D) 94 mm (W) x 43 mm (H) x 34 mm (D)		
Weight: 2.4 oz (69 g) Input / Output: 9-16 V DC / 5 V DC, 1.5 A			

## 7 Connect the Audio

Decide on one of the following in-box audio connection options. You can also refer to the SiriusXM Dock & Play Vehicle Kit User Guide SXDV3 for additional audio connection options, such as a cassette adapter or the FM Direct Adapter (FMDA) (both sold separately). Go to [www.siriusxm.com/guides](http://www.siriusxm.com/guides) for the User Guide.

**Option 1: Best:** Use the provided **Aux In Cable**, if your vehicle's stereo system has an auxiliary input jack.

- A. Plug one end of the cable into the **green AUDIO** connector on the side of the **PowerConnect Vehicle Dock** and the other end into the auxiliary input jack on the vehicle's stereo system.
- B. Turn on your vehicle's stereo system and set it to play from the auxiliary input source.
- C. You should hear the SiriusXM audio through your vehicle's stereo system.
- D. If you are using the wire guide channel across the back of the Vehicle Dock to organize the wires, place the wires in the guide and then tighten the 4 screws to securely attach the mount.

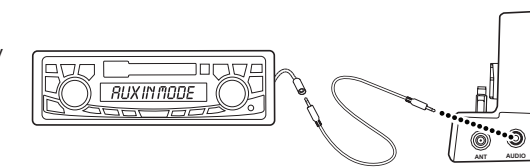

**TIP!** Refer to your vehicle's owner's manual to find the location of the auxiliary input jack, or consult the vehicle dealer.

**Option 2: Good:** Use the **PowerConnect** feature in your Radio. **PowerConnect** plays the audio through your vehicle's FM radio.

- A. Use the SiriusXM FM Channel Finder at [www.siriusxm.com/fmchannel](http://www.siriusxm.com/fmchannel). Go to the website and enter your zip code. The Channel Finder will suggest a list of available FM channels in your area. For convenience, write down or print out the list.
- B. Pick the first FM channel on your list. Tune your vehicle's FM radio to this FM channel. You should only hear static or silence. If not, try the next FM channel on your list.
- C. Set your satellite Radio to transmit on the same FM channel that you have selected on your vehicle's FM radio. You may need to turn On the FM Transmitter in your Radio first. Go to [www.siriusxm.com/guides](http://www.siriusxm.com/guides) for your Radio's User Guide (with Vehicle Kit) for instructions. You should now hear the SiriusXM audio.

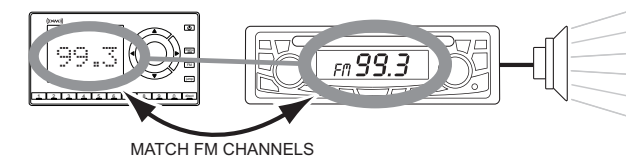

MATCH FM CHANNELS

- D. If you are not satisfied with the audio quality, move to the next FM channel on your list and repeat the process. Continue until you have found an FM channel with which you are satisfied.
- E. If you are using the wire guide channel across the back of the Vehicle Dock to organize the wires, place the wires in the guide and then tighten the 4 screws to securely attach the mount.

**TIP!** You may find an FM channel with static or silence on your vehicle's FM radio that does not work with your satellite Radio. It is possible that some type of inaudible interference is present that prevents reception of the SiriusXM broadcast. Your only options are to use another FM channel or a different audio connection method.

## Important Legal Information

©2014 Sirius XM Radio Inc. "Sirius", "XM" and all related marks and logos are trademarks of Sirius XM Radio Inc. Visit [www.siriusxm.com/channellineup](http://www.siriusxm.com/channellineup) for updates. All programming/channel lineup/XM service subject to change or preemption. All other marks and logos are the property of their respective owners. All rights reserved. Our satellite service is available only to those at least 18 and older in the 48 contiguous USA and DC. Our Sirius satellite service is also available in PR (with coverage limitations). Our Internet Radio service is available throughout our satellite service area and in AK and HI. Certain channels are not available on our Internet Radio service or on mobile devices. **WARNING:** This product contains chemicals known to the State of California to cause cancer and birth defects or other reproductive harm.

## ? What's in the Box?

**CAUTION:** Do not attempt to install, activate, or adjust any of the setting options described in this Quick Start Guide unless your vehicle is parked in a safe location.

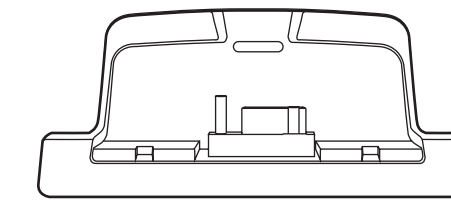

PowerConnect™ Vehicle Dock

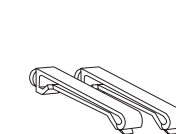

Vent Mount and Extended Vent Clamps

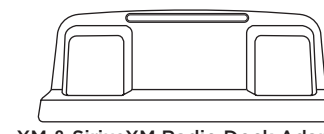

XM & SiriusXM Radio Dock Adapter

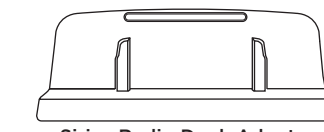

Sirius Radio Dock Adapter

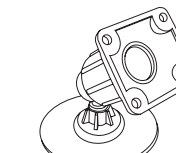

Dash Mount

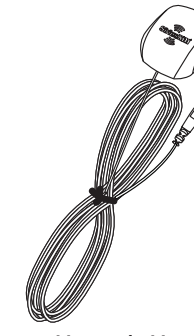

Magnetic Mount Antenna



Antenna & Dash Mount Alcohol Preparation Pads

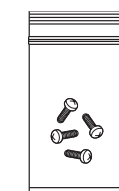

Screws (4)

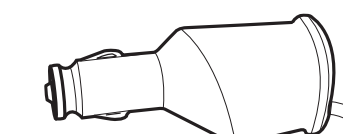

PowerConnect Power Adapter



Aux In Cable