

CleanSweep® CL-SSI

signal-summing interface



OWNER'S MANUAL

*Thank you for purchasing a JL Audio CleanSweep®
Signal-Summing Interface for your automotive sound system.*

*This product has been designed and manufactured to exacting standards
in order to ensure years of musical enjoyment in your vehicle.*

*For maximum performance and extended warranty
coverage, we highly recommend that you have your CL-SSI installed by
an authorized JL Audio dealer. Your authorized dealer has the training,
expertise and installation equipment to ensure optimum performance
from this product without compromising your vehicle's functionality.
Due to the complexity of modern vehicle systems we do not recommend
self-installation unless you have extensive experience in
automotive electrical systems.*

*If you have any questions regarding the instructions in this
manual or any aspect of the product's operation, please contact your
authorized JL Audio dealer for assistance. If you need further assistance,
please call the JL Audio Technical Support Department
at (954) 443-1100 during business hours.*



SERIAL NUMBER

In the event that your CleanSweep® CL-SSI requires service or is ever stolen, you will need to have a record of the product's serial number. Please take the time to enter that number in the space provided below. The serial number can be found on the bottom panel of the unit and on the packaging.

Serial Number:

PROTECT YOUR HEARING!

We value you as a long-term customer. For that reason, we urge you to practice restraint in the operation of this product so as not to damage your hearing and that of others in your vehicle. Studies have shown that continuous exposure to high sound pressure levels can lead to permanent (irreparable) hearing loss. Automotive audio systems are capable of producing such high sound pressure levels. Please limit your continuous exposure to high volume levels.

While driving, operate your audio system in a manner that still allows you to hear necessary noises to operate your vehicle safely (horns, sirens, etc.).

INSTALLATION APPLICATIONS

This product is designed for operation in vehicles with 12V, negative-ground electrical systems. Use of this product in vehicles with positive ground and/or voltages other than 12V may result in damage to the product and will void the warranty.

This product is not certified or approved for use in aircraft.

PLANNING YOUR INSTALLATION

It is important that you take the time to read this manual and that you plan out your installation carefully.

The CL-SSI should be mounted as close to the CL441dsp as possible. The harness supplied for connecting the CL-SSI's outputs to the inputs of the CL441dsp is 3 feet (91 cm) long.

Safety Considerations:

Your CleanSweep® CL-SSI needs to be installed in a dry environment and in a manner which does not interfere with your vehicle's safety equipment (air bags, seat belt systems, ABS brake systems, etc.). You should also take the time to securely mount the CleanSweep® CL-SSI that it does not come loose in the event of a collision or sudden acceleration / deceleration.

Stupid Mistakes to Avoid:

- Check before drilling any holes in your vehicle to make sure that you will not be drilling through a gas tank, brake line, wiring harness or other vital vehicle system.
- Do not run system wiring outside or underneath the vehicle. This is an extremely dangerous practice that can result in severe damage to your vehicle and person.
- Protect all system wires from sharp metal edges and wear by carefully routing them, tying them down and using grommets and loom where appropriate.
- Do not mount this product in the engine compartment, under the vehicle, on the roof or in any other area that will expose it to the elements.

PRODUCT OVERVIEW

The CleanSweep® CL-SSI is a dedicated signal summing interface designed specifically for use with the JL Audio CleanSweep® CL441dsp OEM interface processor. Use of the CL-SSI with other equipment is not supported by JL Audio.

This product performs the following functions:

- 1) The CL-SSI sums 2-way or 3-way stereo OEM signals to full-range and outputs the summed signals to a CL441dsp for response correction.
- 2) The CL-SSI is designed to accept virtually any analog audio signal, from low-voltage line-level to high-power, amplified speaker-level, via its three input sections. Input Range Switching allows any combination of line-level and speaker level signals to be used as inputs. When switched to speaker level input mode, the CL-SSI's audio inputs are compatible with OEM head units and amplifiers that employ load-sensing startup logic.
- 3) "Level Trim" potentiometers on the top of the CL-SSI allow for quick and accurate level-matching of signals. Each input features a green LED optimum level indicator flanked by LED's indicating "Too Low" or "Too High." In most cases, no additional equipment is necessary for level matching the inputs.
- 4) Differential-Balanced Input architecture ensures noise immunity and compatibility with most analog output OEM source units or amplifiers.
- 5) The CL-SSI can be set up in signal-sensing mode, powering up and providing a 12-volt turn-on signal for the CL441dsp whenever signal is detected at its inputs. It can also be activated by a conventional 12-volt trigger, in the rare event that the OEM system provides one.

POWER AND TURN-ON CONNECTIONS

Before installing the CL-SSI, disconnect the negative (ground) wire from the vehicle's battery. This will prevent accidental damage to the system, the vehicle and your body during installation.

The CL-SSI has a 4-pin inline jack located next to the "SIGNAL SENSE" switch on the signal output end of the processor (see diagram on page 5). This jack accepts the following connections through the included color-coded wiring harness and plug assembly:

"**+12 V**": Constant +12V

"**GND**": Chassis Ground

"**IGN**": Switched +12V

"**REM.OUT**": Amplifier turn-on (+12V)

Since the CL-SSI does not draw very much current during operation, 18 AWG - 16 AWG wire is ample for making all of these connections. Use good-quality crimp connectors (or solder and heatshrink tubing) to join the harness leads to any extended wires. Any wires run through metal barriers (such as firewalls), must be protected with a high quality rubber grommet to prevent damage to the insulation of the wire. Failure to do so may result in a dangerous short circuit.

Ideally, the "+12V" (constant) and "GND" (chassis ground) connections should be run to the same distribution points that the amplifiers and CL441dsp use for their power and ground connections. This minimizes the possibility of noise in the system.

The "REM.OUT" (Remote Output) connection provides turn-on voltage to the CL441dsp, which in turn will provide turn-on voltage to the rest of the aftermarket audio equipment in the system.

The CL-SSI will only turn on when +12V is present at its "IGN" connection. Conversely, the CL-SSI will immediately shut off as soon as +12V is removed from this connection. If the OEM system does not provide a +12V turn-on lead (most do not), we recommend that you connect this wire to a 12-volt circuit in the car that is only energized with the key in the "Accessory" (ACC) or "Ignition" (IGN) positions. This will ensure that the audio system will only operate with the key in ACC or IGN positions. If the OEM system provides a +12V turn-on lead (rare) you can connect this turn-on lead to the "IGN" connection.

SIGNAL SENSE MODES

The CL-SSI is designed to act as a turn-on and turn-off controller for the CL441dsp, which will control the turn-on of the rest of the aftermarket equipment in the system. There are two modes of turn-on operation which can be selected via the "SIGNAL SENSE" slide-switch located next to the CL-SSI's power connector.

Note: The "SIGNAL SENSE" switch of the CL441dsp must be set to "Off" when used with a CL-SSI.

Signal Sense: ON

With its "SIGNAL SENSE" switch in the "On" position, the CL-SSI will only wake up and turn on the CL441dsp when it senses +12V at its "IGN" terminal and also senses an input signal from the OEM audio source. This mode requires that the "IGN" terminal of the CL-SSI be connected to a vehicle wire with accessory/ignition-switched +12V. (See diagram on page 5.)

If the vehicle is turned on with the OEM source unit turned off, the CL-SSI will remain in Standby Mode until the OEM source is turned on and playing. The CL-SSI will go into Standby Mode (off) approximately one minute after it senses a loss of input signal or as soon as the ignition is turned off (whichever comes first).

Signal Sense: OFF

With its "SIGNAL SENSE" switch in the "Off" position, the CL-SSI will wake up and provide +12V at its "REM.OUT" terminal whenever it senses +12V at its "IGN" terminal (regardless of whether the OEM source is on or not). This position can be useful if another device is being used to toggle the CL-SSI on/off, or if the OEM system has a conventional +12 V turn-on output (very rare). The "Off" position can also be used with a manual switch on the wire feeding the "IGN" terminal for those who desire manual control of on/off functions. This switch should be connected to an ignition-switched +12V to prevent accidental battery drainage.

POWER AND TURN-ON CONNECTION DIAGRAM

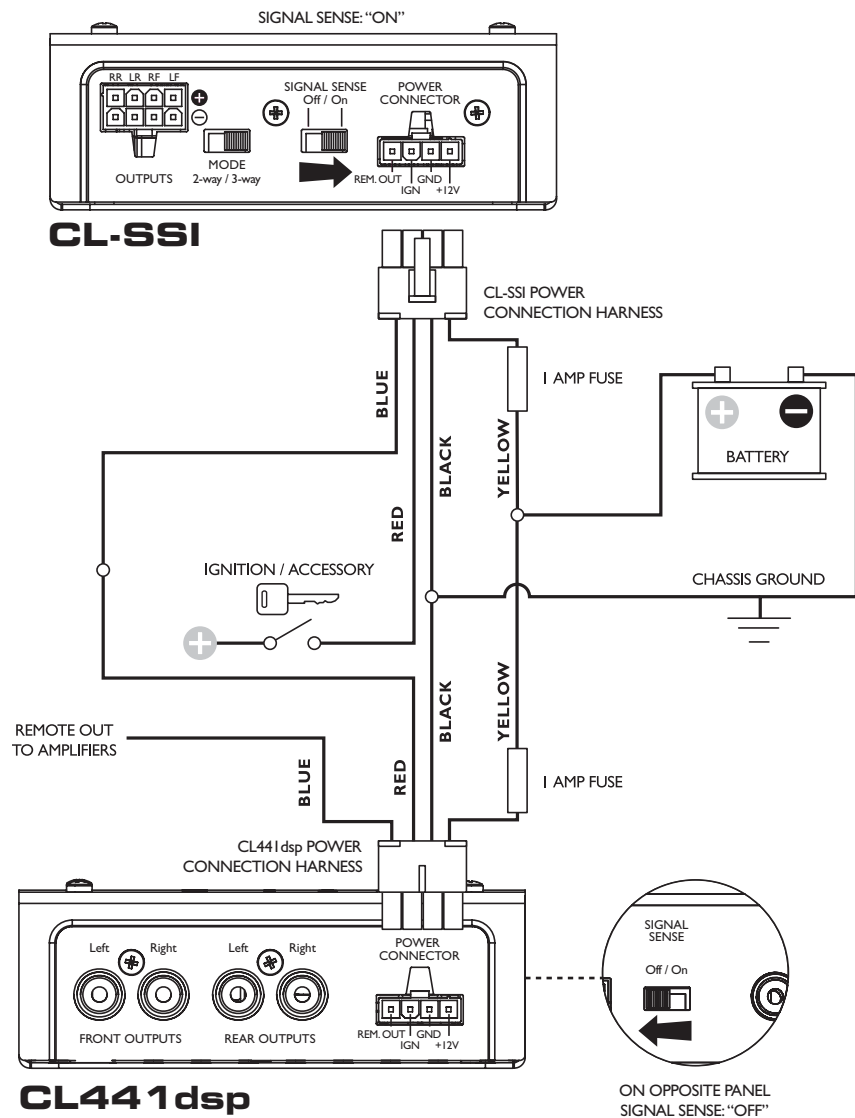

IMPORTANT

The CL441dsp's "SIGNAL SENSE" switch must be set to "OFF" when used with the CL-SSI. The CL-SSI will act as the CL441dsp's signal-sensing turn-on control. The CL441dsp will provide the turn-on voltage to the rest of the system, ensuring that the equipment will turn on and off in the appropriate order, eliminating pops and thumps.

FUSE REQUIREMENTS

The +12V constant wire on the CL-SSI power harness has an inline 1 amp, fast blow AGC (small glass-bodied) fuse for protection of the unit. Do not remove this fuse or replace it with a different value of fuse.

OUTPUT CONNECTIONS

The CL-SSI's output harness is designed for direct connection to the "OEM INPUT CONNECTOR" of the CL441dsp. The harness provided is 3 ft. (91 cm) long. Should you need a longer length, you can cut the harness and splice extended wires to the harness. Runs longer than 6ft. (182 cm) will benefit from twisted-pairs of wires for each channel to avoid noise. Whenever possible, locate the CL-SSI within reach of the CL441dsp with the included harness.

OUTPUT CONNECTION DIAGRAM

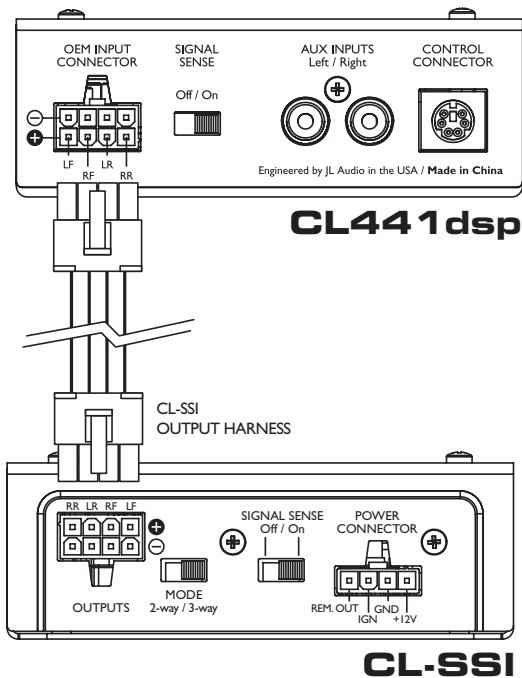

OEM INPUT CONNECTIONS

The CL-SSI accepts up to six channels (three stereo pairs) of band-limited input from an OEM audio source via the three 4-pin plugs located on the input panel of the main processor (see diagram on page 9). Three color-coded input harnesses are included for connection to each of these plugs.

The input architecture of the CL-SSI is set up in a differential-balanced configuration, making its inputs compatible with virtually any analog audio signal.

Depending on the specific architecture of your OEM system, you will need to choose appropriate connection points that maintain OEM functionality and provide appropriate input to the CL-SSI. It is recommended that you obtain a service manual for the vehicle you are working on in order to locate and identify the correct OEM wires.

Please refer to the following pages for detailed information on the summing capabilities of the CL-SSI.

!! WARNING

It is very easy to damage expensive vehicle systems in modern automobiles. Never assume that you have found appropriate wires without consulting a reliable wiring diagram or without performing signal testing with safe test equipment. If you are not comfortable with reading wire diagrams or testing signals, please enlist the services of your authorized JL Audio dealer to perform the installation.

! IMPORTANT

It is vital to observe correct electrical polarity on each channel when making input connections. Failure to do so will result in unrecoverable frequency response problems.

2-WAY OR 3-WAY SUMMING MODES:

The CL-SSI can be operated in two distinct modes to address OEM signals that have been filtered using 2-Way or 3-Way crossovers. These modes are selected via the “MODE” switch located next to the “OUTPUTS” connector on one end of the unit.

2-Way Mode:

In this mode, the CL-SSI will sum an OEM subwoofer (or woofer) signal to front and rear signals that have been high-pass filtered, creating front and rear full-range output channels while retaining the functionality of the OEM front-to-rear fader control.

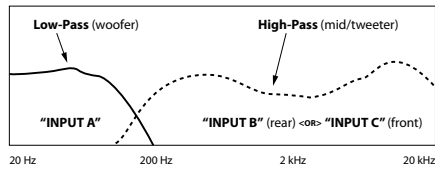

To use the CL-SSI in this mode:

- 1) Flip the “MODE” switch to “2-way”.
- 2) Connect the OEM subwoofer or woofer signals to “Input C”. If this signal is mono (one channel only), connect this signal to both the left and the right channels of “Input C”, in parallel.
- 3) Connect the rear high-pass signals to “Input B”.
- 4) Connect the front high-pass signals to “Input A”.
- 5) Using the “Level Trim” controls, calibrate the Input Levels according to the Calibration Procedure described on page 10.
- 6) Once properly calibrated, the CL-SSI will output front and rear full-range stereo signals to the CL441dsp as shown in the example below.

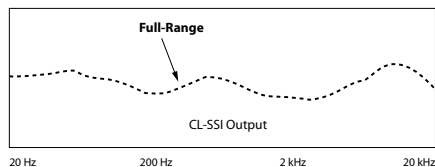

3-Way Mode:

In the 3-Way mode, the CL-SSI will sum an OEM subwoofer or woofer signal (low-pass filtered) to a mid-bass or midrange signal (bandpass filtered) and to a high frequency signal (high-pass filtered), creating a two-channel, full-range stereo output.

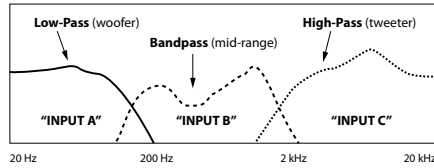

To use the CL-SSI in this mode:

- 1) Flip the “MODE” switch to “3-way”.
- 2) Connect the OEM subwoofer or woofer signals to “Input C”. If this signal is mono (one channel only), connect this signal to both the left and the right channels of “Input C”, in parallel.
- 3) Connect the bandpass-filtered midrange signals to “Input B”.
- 4) Connect the high-pass filtered signals to “Input A”.
- 5) Using the “Level Trim” controls, calibrate the Input Levels according to the Calibration Procedure described on page 10.
- 6) Once properly calibrated, the CL-SSI will output a single pair of full-range stereo signals to the CL441dsp as shown in the example below. The CL-SSI will provide the same two-channel signal at its front and rear outputs, feeding all four channels of the CL441dsp.

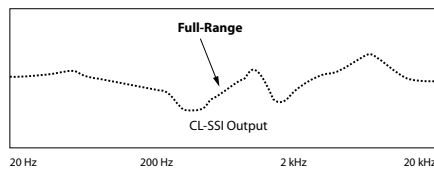

OEM INPUT CONNECTION DIAGRAM

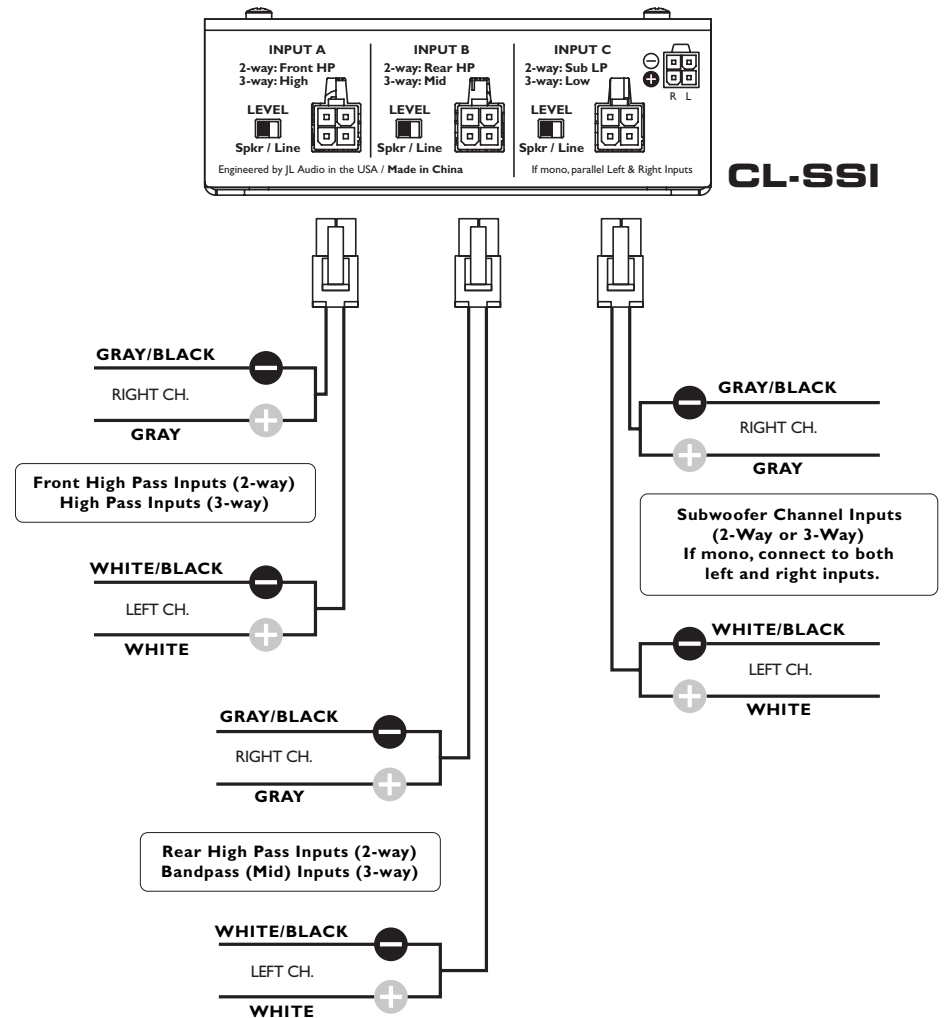

CL-SSI

LEVEL MATCHING SIGNALS

Proper level matching of the signals being summed is essential to achieving a successful calibration of the CL441dsp.

To aid in proper level matching, each of the CL-SSI's "Level Trim" sections features a green LED optimum level indicator flanked by LED's indicating level "Too Low" or level "Too High."

The "Level Trim" potentiometers on the top of the CL-SSI allow the user to accurately match the levels of the signals being summed using the "CleanSweep® Calibration CD" (included with the CL441dsp). Please read the following section for details on calibrating the CL-SSI's "Level Trim" controls.

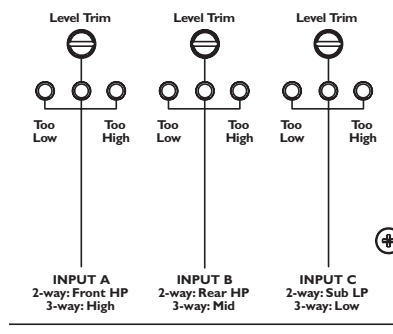

! IMPORTANT

The CL-SSI's level matching procedure requires the use of the "CleanSweep® Calibration CD" included with the CL441dsp. The CL-SSI's level indicators have no significance with any other test-signal or with music program material!

CALIBRATION PROCEDURE

Once you have made all your system connections, follow these steps precisely:

- 1) Select the appropriate summing mode on the CL-SSI and set the three "Input Level" switches to "Speaker" position.
 - a) If you are summing a subwoofer signal to front and rear high-pass signals (2-way, four channel sum), switch the "MODE" switch to "2-way".
-OR-
 - b) If you are summing a subwoofer signal to mid-range (bandpass) signals and high-pass signals (3-way, two channel sum), switch the "MODE" switch to "3-way".
- 2) Turn the CL441dsp's Master Volume Knob all the way DOWN.
- 3) Reconnect the vehicle's battery ground.
- 4) Turn the OEM head unit on and make sure it is playing something (radio or CD, doesn't matter right now). Set all OEM head unit tone controls at "0" (flat), and the balance and fader controls at their center positions. Turn off any additional factory signal processing features like "Loudness", "Stadium", "Hall", "Sheep Barn", etc.
- 5) Verify that the CL-SSI has turned on (lights on, any color) and has turned on the rest of the aftermarket equipment, including the CL441dsp.
- 6) Slightly raise the CL441dsp's Master Volume and verify that audio is passing through to the aftermarket system. Once verified, turn the CL441dsp's Master Volume Control back to minimum.
- 7) Insert the "CleanSweep® Calibration CD" (included with the CL441dsp) into the OEM CD player, play Track 01 and set the OEM head unit volume control between half and 3/4 of full volume.

- 8) Using the rotary "Level Trim" controls on the top of the CL-SSI, level match the signals so that each LED indicator is steady green. If you have turned any control to its full clockwise rotation and have not achieved a green light, flip the "Input Level" switch for that input to "Line" and retry. Once you have three green lights, you have achieved a successful level match.
- 9) Using a small pointed tool press the CL441dsp's "CALIBRATE" button.
- 10) Wait approximately twenty seconds... lights will flash in various colors to keep you entertained and to indicate that calibration is taking place. After twenty seconds, the lights will have stabilized and will tell you whether the calibration has been successful on each channel.
- 11) If you have four green lights, your calibration was successful. If you don't have steady green lights, refer to the Channel Status Codes section in the CL441dsp manual for troubleshooting.
- 12) If you have steady green lights on the CL441dsp, you can now proceed to set your amplifier input sensitivities. Handy test tones are included for this purpose on the "CleanSweep® Calibration CD"... then balance your amplifier channels to taste.
- 13) Refer to CL441dsp manual for Aux Input level setting information.
- 14) That's it! You're now ready to enjoy great sound.

SPECIFICATIONS

CleanSweep® CL-SSI

Signal Summing Interface

Electrical Specifications:

Power Supply Type: PWM Switching Supply - Regulated
Operating Voltage: 9 - 16V DC
Standby Mode Current Draw: < 2 mA
Operating Current Draw: 0.5 A at 13.8V
Recommended Fuse Value: 1 A (Fast Blow)
Recommended Fuse Type: AGC

OEM Input Section:

No. of Input Channels: Three Stereo Pairs
Input Type: Differential-balanced with eight-pin jack
Input Range: 100mVrms - 20Vrms
Input Level Setting: Manual with calibrated LED indicators

Output Section:

No. of Output Channels: Two Stereo Pairs
Output Type: Unbalanced, via multi-pin jack
Maximum Output Voltage: 8 Vrms (per output)
Output Impedance: 470 ohms
Signal to Noise Ratio: <108 dB (with A-Weighted filter at 8.0 Vrms, 20Hz-20kHz)
THD + Noise: < 0.01% at 8.0 Vrms (20Hz - 20 kHz)

Dimensions: (LxWxH):

5.02 in. x 4.36 in. x 1.52 in. (128 mm x 111 mm x 39 mm)

PARTS LIST

- (1) CL-SSI Signal Summing Interface
- (1) Power connection harness
- (3) Input connection harnesses
- (1) Output connection harness

Due to ongoing product development, all specifications are subject to change without notice.

LIMITED WARRANTY - ELECTRONICS (USA)

JL AUDIO warrants this product to be free of defects in materials and workmanship for a period of ninety (90) days from the original date of purchase. The warranty term is extended to two (2) years if installation is performed or approved by an authorized JL AUDIO dealer (proof of installation or approval required on purchase receipt).

This warranty is not transferrable and applies only to the original purchaser from an authorized JL AUDIO dealer. Should service be necessary under this warranty for any reason due to manufacturing defect or malfunction, JL AUDIO will (at its discretion), repair or replace the defective product with new or remanufactured product at no charge. Damage caused by the following is not covered under warranty: accident, misuse, abuse, product modification or neglect, failure to follow installation instructions, unauthorized repair attempts, misrepresentations by the seller. This warranty does not cover incidental or consequential damages and does not cover the cost of removing or reinstalling the unit(s). Cosmetic damage due to accident or normal wear and tear is not covered under warranty.

Warranty is void if the product's serial number has been removed or defaced.

Any applicable implied warranties are limited in duration to the period of the express warranty as provided herein beginning with the date of the original purchase at retail, and no warranties, whether express or implied, shall apply to this product thereafter. Some states do not allow limitations on implied warranties, therefore these exclusions may not apply to you. This warranty gives you specific legal rights, and you may also have other rights which vary from state to state.

If you need service on your JL AUDIO product:

All warranty returns should be sent to JL AUDIO's Electronics Service Facility freight-prepaid through an authorized JL AUDIO dealer and must be accompanied by proof of purchase (a copy of the original sales receipt). Direct returns from consumers or non-authorized dealers will be refused unless specifically authorized by JL AUDIO with a valid return authorization number.

Warranty expiration on products returned without proof of purchase will be determined from the manufacturing date code. Coverage may be invalidated as this date is previous to purchase date. Non-defective items received will be returned freight-collect. Customer is responsible for shipping charges and insurance in sending the product to JL AUDIO. Freight damage on returns is not covered under warranty.

For Service Information in the U.S.A. please call:

JL Audio customer service: (954) 443-1100

during normal business hours (9:00 AM - 5:30 PM Eastern Time)

JL Audio, Inc

10369 North Commerce Pkwy.

Miramar, FL 33025

(do not send product for repair to this address)

International Warranties:

Products purchased outside the United States of America are covered only by that country's distributor and not by JL Audio, Inc.